

elite **one piece canopy**



Elite Party Canopy:
Stylish backyard canopies with a distinctive peaked roof and optional color band.

Elite Party Canopy Construction Features:

- 13-14 oz.vinyl laminate tent fabric
- Anodized sectional aluminum poles
- Stamped aluminum side pole fittings
- Reinforced corners and pole positions
- Storm lines at all center poles
- Sidewall ropes
- Attached/braided guy lines with sliders
- Storage bags included

Available Colors: Solid White, Red/White, Blue/White, Yellow/White and Green/White

Available in: 20' and 30' widths

elite one piece canopy

ASSEMBLY [20'x30' SHOWN] :

1. Inspect the site and make sure the area is level, free of utilities and overhangs. Unload poles and tent bundles.

2. Lay the canopy out, on a ground cloth, with the top side up. Stretch and square the fabric to remove slack. Pull the guy ropes out from the canopy. See fig.1.

- Thread one of the guy ropes through a hole in a slider.
- Thread the end of the rope through the remaining hole in the slider and tie a knot to secure. To work properly, the rope must enter slider from the same side each time- as illustrated. Repeat with remaining guy ropes and sliders. See fig.2.

3. Drive the stake 4' out and at a slight angle away from the canopy. Stake the corners first, using two stakes placed at 90° from each corner. See fig.1. Continue staking until all guy ropes are at 4'. Be sure to leave enough slack in the guy ropes to raise the poles. Additional stakes will be necessary in soft soil conditions or whenever stakes pull up from the ground.

4. If using aluminum poles, assemble them making sure each snap button is secured.

5. Install the side poles from the underside of the canopy. Insert pole pins up through both the grommet and the aluminum fitting. See fig.3. Stand the poles up at a 60° angle with their base toward the center of the tent. Set the corner poles first, then the side poles. See fig.4.

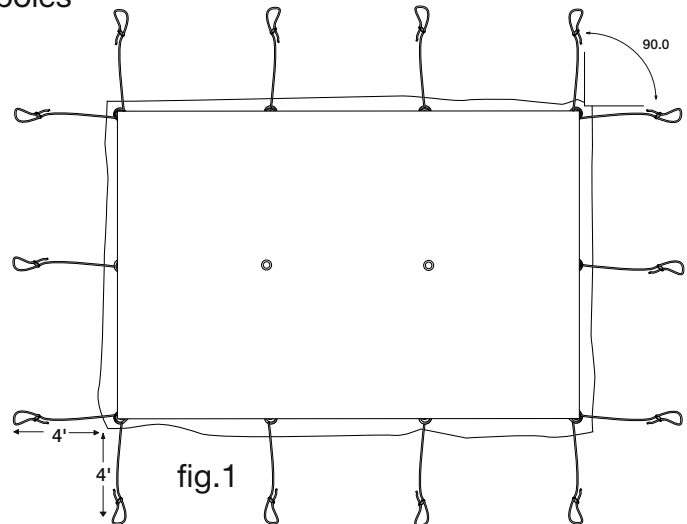

fig.1

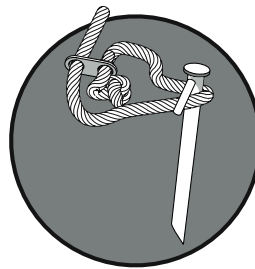

fig.2

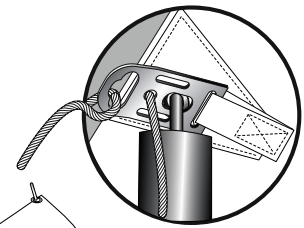

fig.3

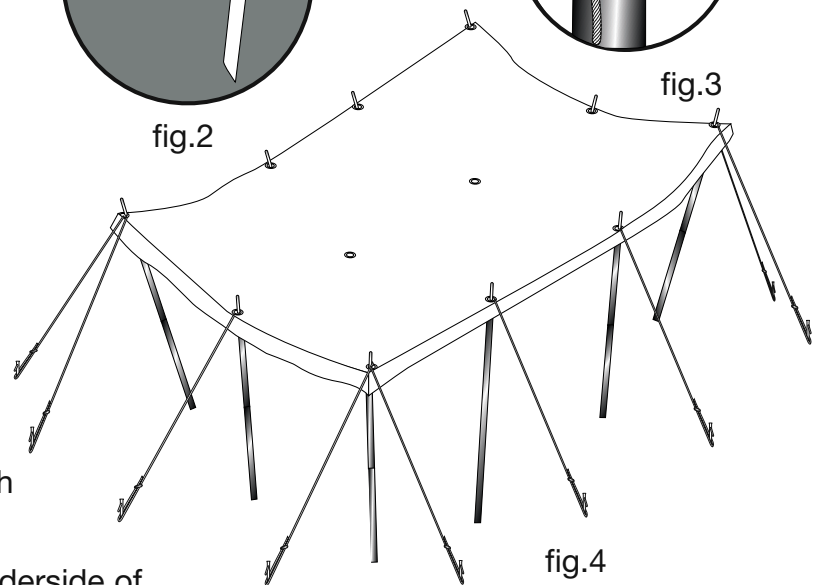
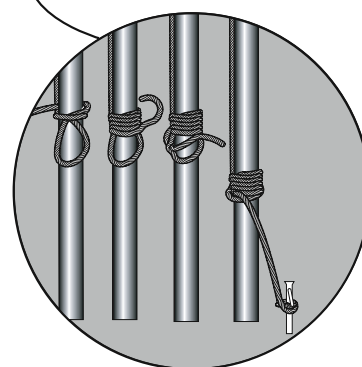
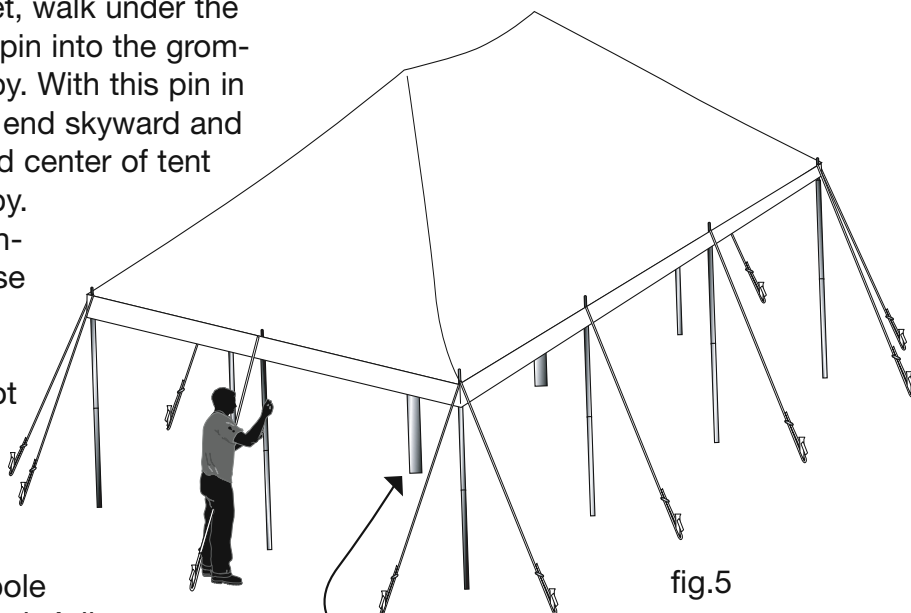

fig.4

elite **one piece canopy**

6. With the perimeter poles set, walk under the tent and insert center pole pin into the grommet at the top of the canopy. With this pin in place, lift and push the pin end skyward and the center pole base toward center of tent to raise the pole and canopy.

- If your tent has multiple center poles, the first pole base should be angled at 45° to center. Stake the base of this pole so that it does not slip. Raise the remaining center poles. When you have reached the 45° angles, stake each pole. Return to the first center pole and adjust to almost vertical. Adjust the other poles to almost vertical until all center poles are raised and adjusted.
- With all center poles almost vertical, bring them into line. Have someone stand at one end of the tent. Align each center pole as directed by that person. Then align each center pole from the sides of the tent. See fig.5.



7. If the top of the center pole appears to be leaning toward one end:
- Tighten guy ropes and straighten side poles, at the end opposite the lean, to pull the center pole back to true.
 - Then straighten and adjust the guy ropes at the other end. Be careful, do not pull the center pole out of alignment.
 - When center poles appear vertical, adjust opposing end side poles simultaneously to avoid drawing the entire tent toward one side or the other. After end side poles are adjusted and guy ropes are secured, repeat down the length of the tent. Again, avoid pulling or drawing entire tent to one side or the other.

- Tie jump ropes to the side poles to secure. To prevent the canopy from lifting the center poles, drive a stake into the ground near the base of the center poles. Tie a jump rope around the pole and to the stake. See fig. 6.

8. If using sidewalls, clip the sidewalls to the valance rope. Sidewalls overlap approximately 2'. Buckle the ends to insure complete enclosure.

NOTE: Severe weather can damage tents. If severe weather is expected, take down the tent and store in a safe area.

elite **one piece canopy**

PARTS & ASSEMBLIES

DESCRIPTION	QNTY	PRODUCT CODE	DESCRIPTION	QNTY	PRODUCT CODE
20x20 1 PC Vin Hd Ftng		2408230	30x40 1 PC Vinyl		2408520
20x20 1 PC Blockout Hd Ftng		2408231	30x40 1 PC Blockout		2408510
20x20 1 PC Vinyl		2408220	2 PC 18' Alum C.P.	2	2470806
20x20 1 PC Blockout		2408210	7' 1.75 Alum S.P.	18	2470128
20x20 Pole Set	1	2408431	36" Nailheads	24	2470126
[inc. 8- 7' Side Poles - 1.75" Heavy Duty]					
2 PC 14' Alum C.P.	1	2470137	30x60 1 PC Vinyl		2408720
24" Steel Stakes	13	2470002	30x60 1 PC Blockout		2408710
			2 PC 18' Alum C.P.	3	2470806
20x30 1 PC Vin Hd Ftng		2408330	7' 1.75 Alum S.P.	24	2470128
20x30 1 PC Blockout Hd Ftng		2408331	36" Nailheads	31	2470126
20x30 1 PC Vinyl		2408320			
20x30 1 PC Blockout		2408310			
20x30 Pole Set	1	2408432			
[inc. 10- 7' Side Poles - 1.75" Heavy Duty]					
2 PC 14" 2.50 Alum C.P.	2	2470137			
24" Steel Stakes	16	2470002			
20x40 1 PC Vin Hd Ftng		2408440			
20x40 1 PC Blockout Hd Ftng		2408441			
20x40 1 PC Vinyl		2408420			
20x40 1 PC Blockout		2408410			
20x40 Pole Set	1	2408433			
[inc. 12- 7' Side Poles - 1.75" Heavy Duty]					
2 PC 14' 2.50 Alum C.P.	3	2470137			
24" Steel Stakes	19	2470002			

NOTE: Also available with red, blue, yellow and green stripes

elite **one piece canopy**

SCHEMATIC

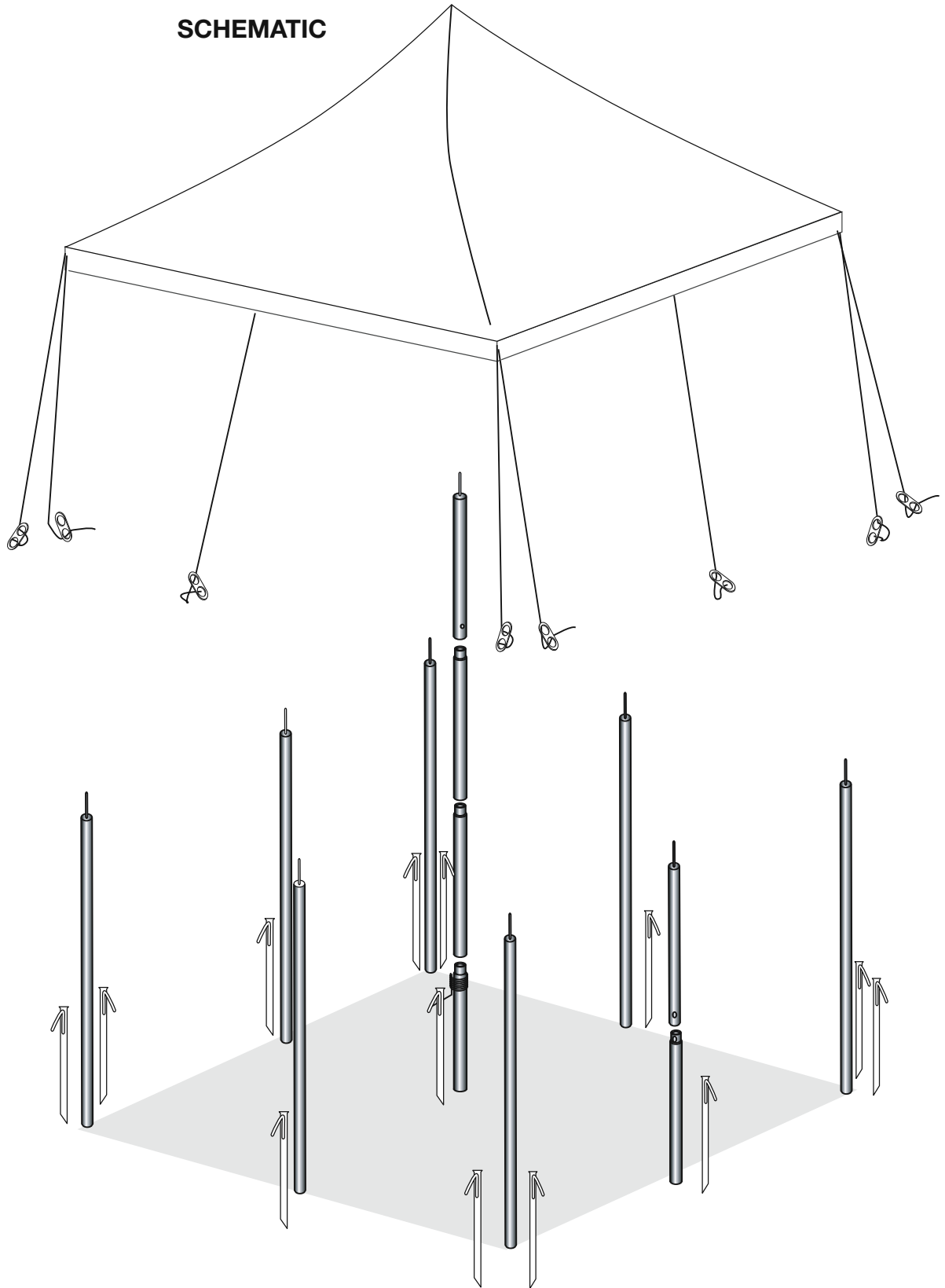

elite **one piece canopy**

20' X 20' WITH 7' SIDES

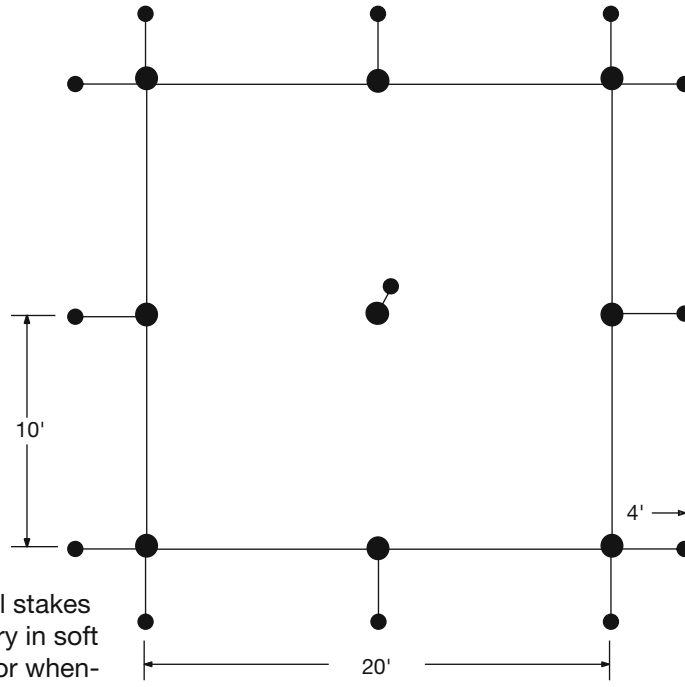

Note: Additional stakes will be necessary in soft soil conditions or whenever stakes pull up from the ground.

PLAN W/STAKES

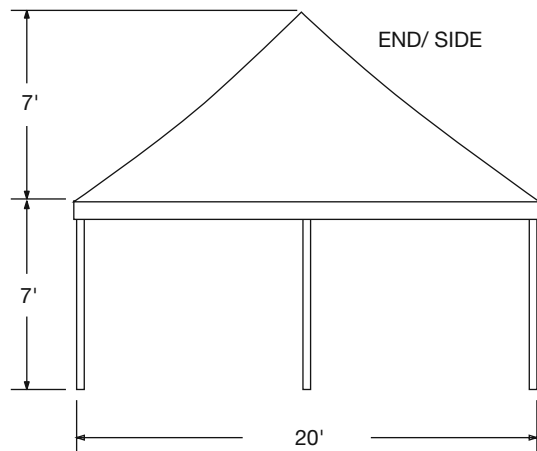

elite **one piece canopy**

20' X 30' WITH 7' SIDES

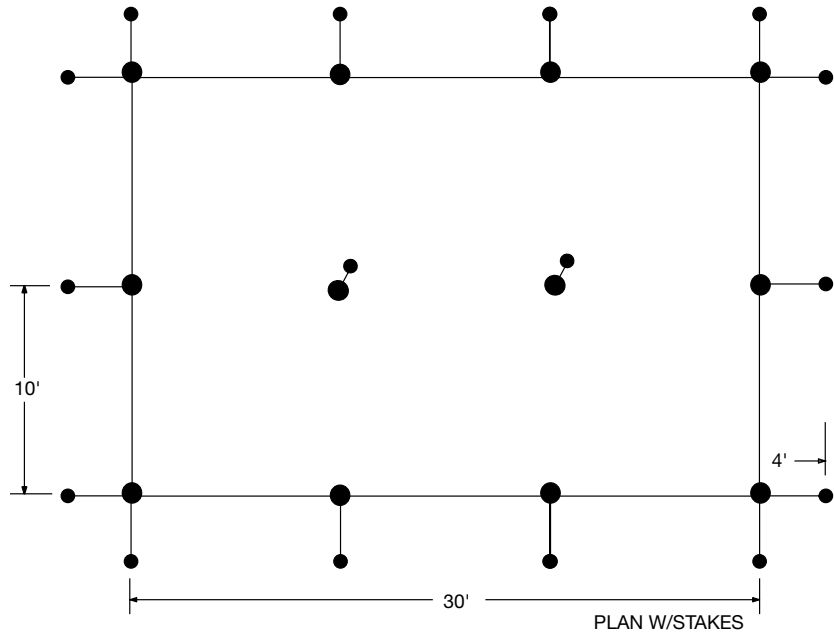

Note: Additional stakes will be necessary in soft soil conditions or whenever stakes pull up from the ground.

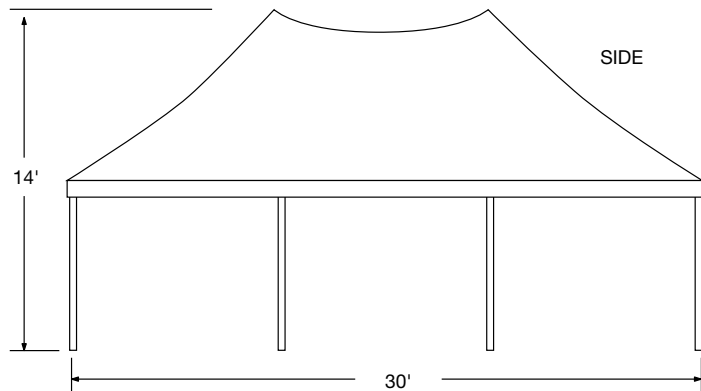
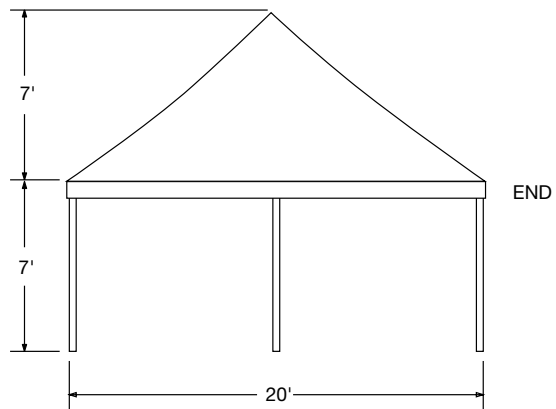

elite **one piece canopy**

20' X 40' WITH 7' SIDES

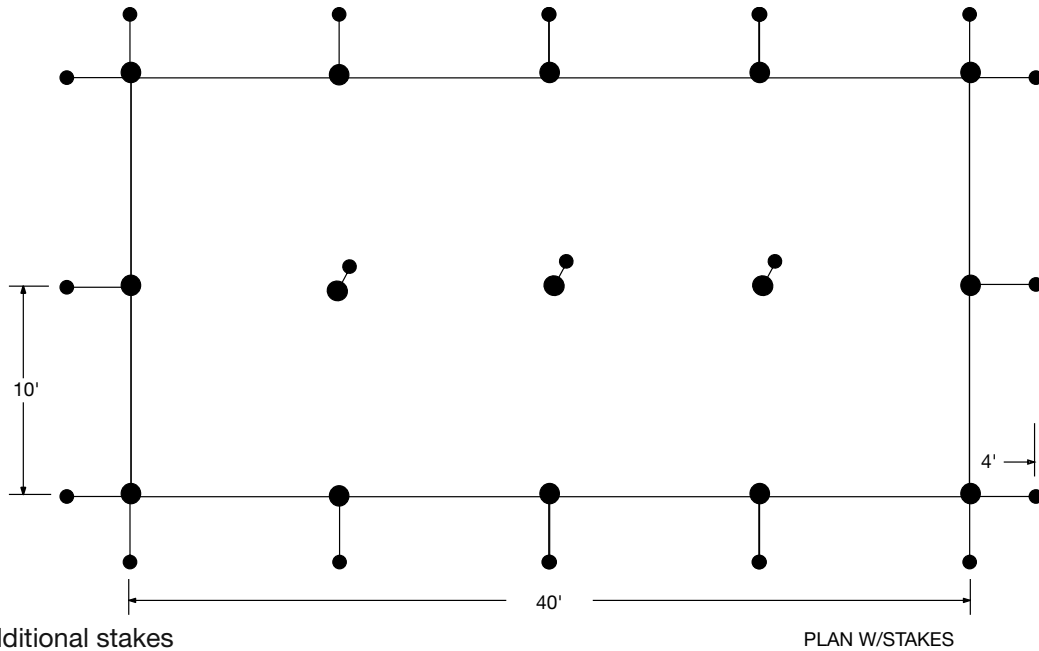

Note: Additional stakes will be necessary in soft soil conditions or whenever stakes pull up from the ground.

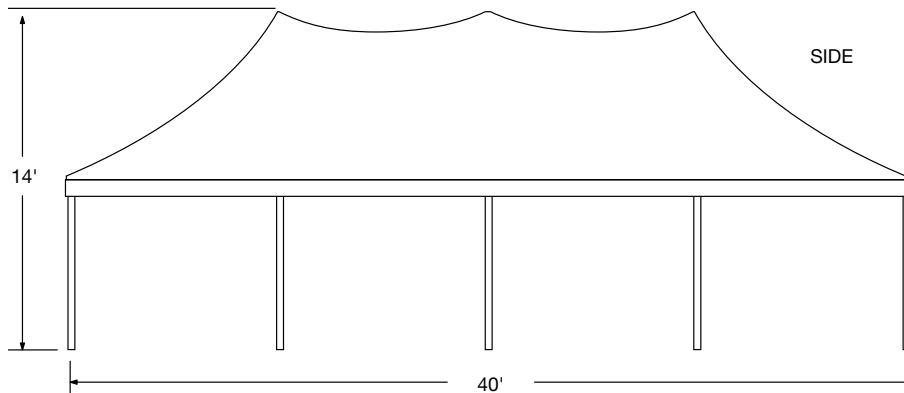
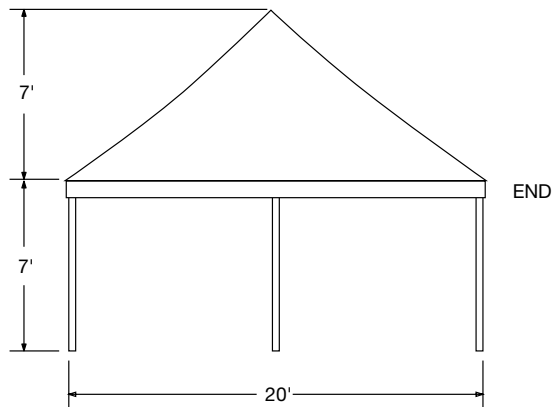

elite **one piece canopy**

30' X 30' WITH 7' SIDES

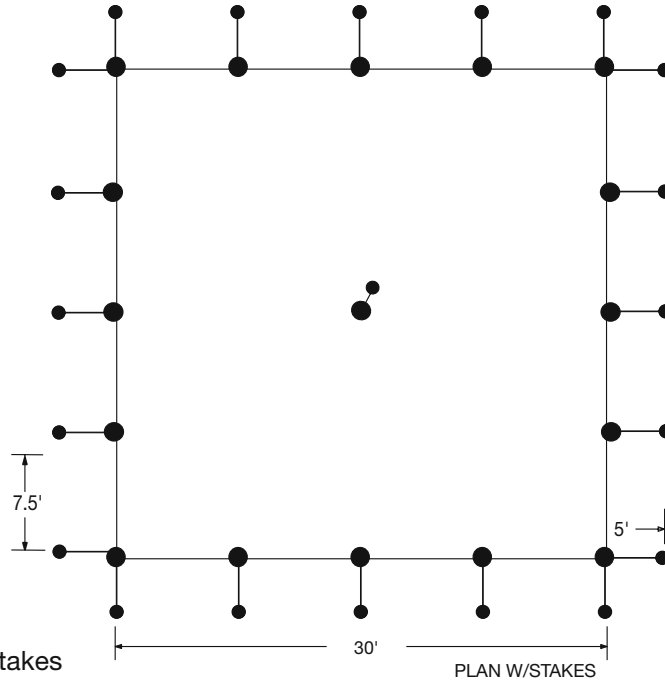

Note: Additional stakes will be necessary in soft soil conditions or whenever stakes pull up from the ground.

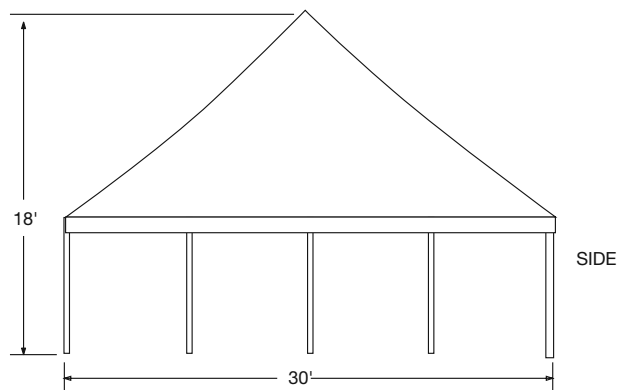
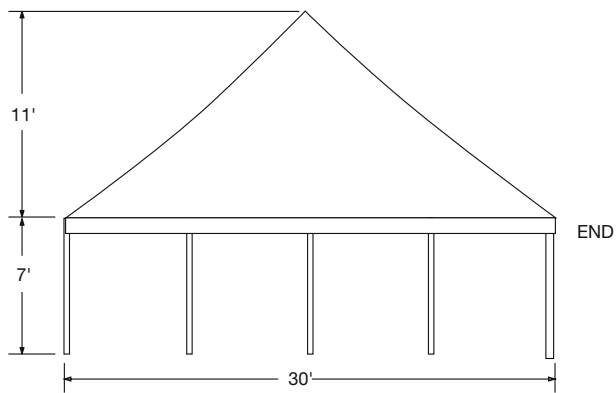

elite **one piece canopy**

30' x 40' WITH 7' SIDES

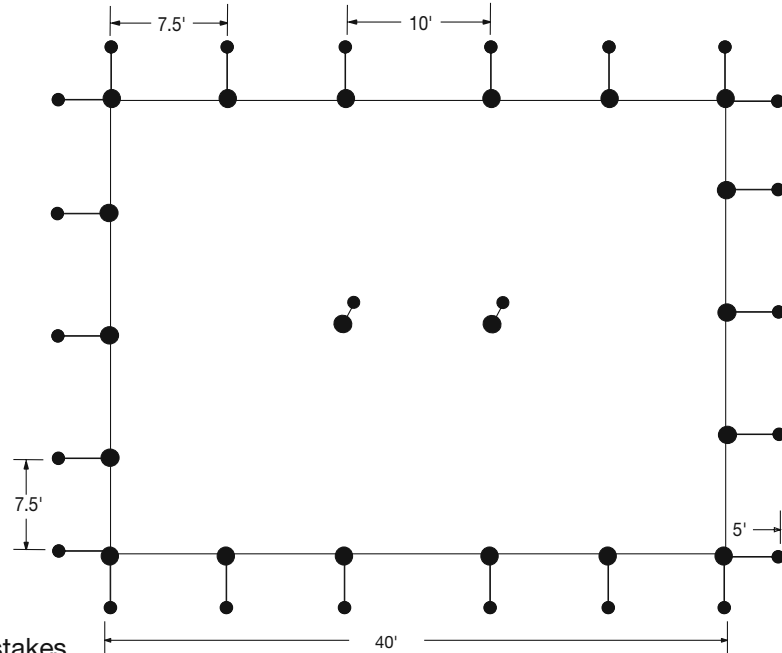

PLAN W/STAKES

Note: Additional stakes will be necessary in soft soil conditions or whenever stakes pull up from the ground.

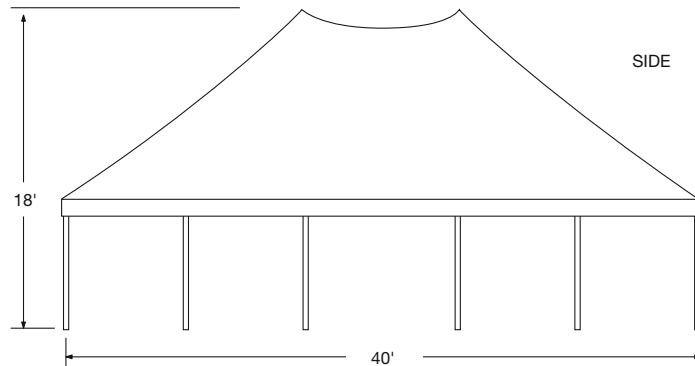
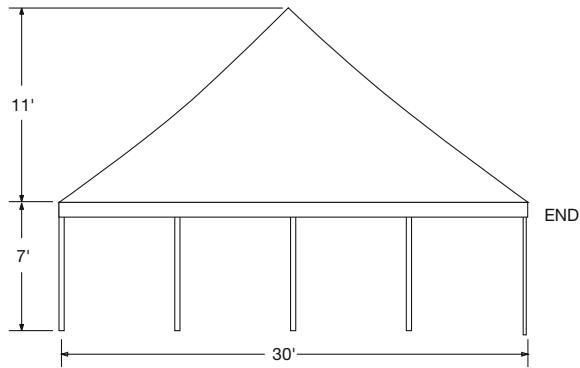

elite **one piece canopy**

30' x 45' WITH 7' SIDES

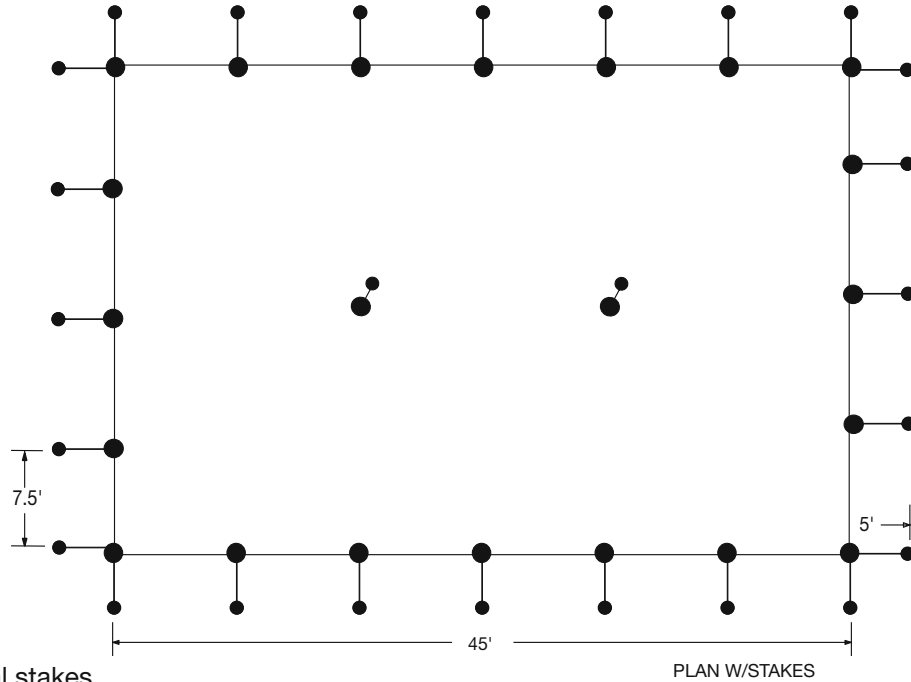

Note: Additional stakes will be necessary in soft soil conditions or whenever stakes pull up from the ground.

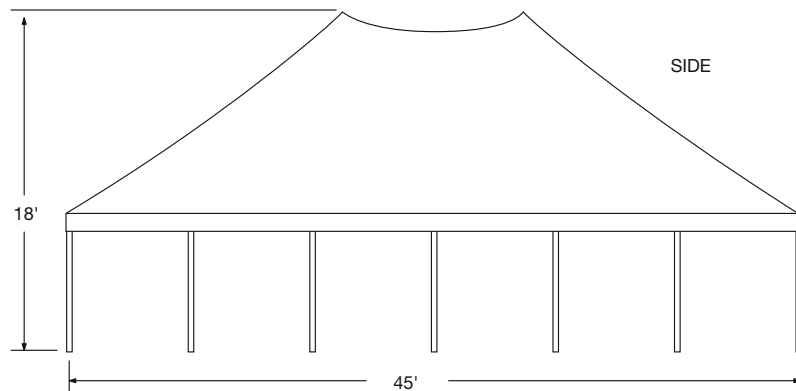
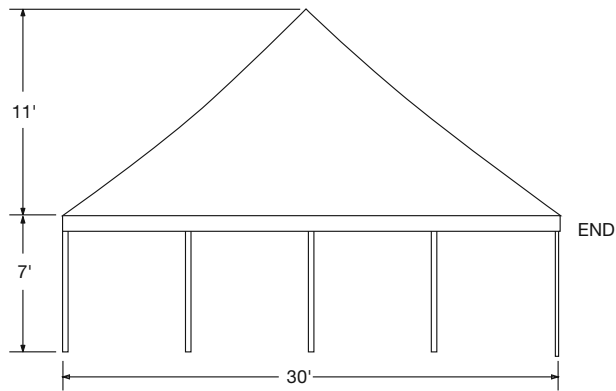

elite **one piece canopy**

30' x 50' WITH 7' SIDES

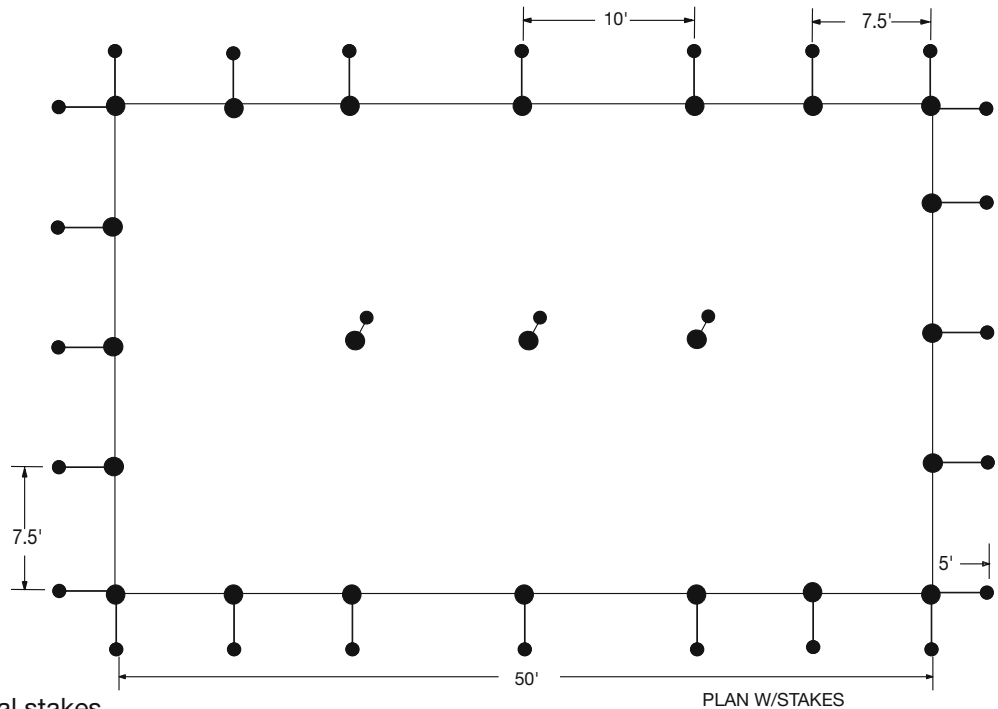

Note: Additional stakes will be necessary in soft soil conditions or whenever stakes pull up from the ground.

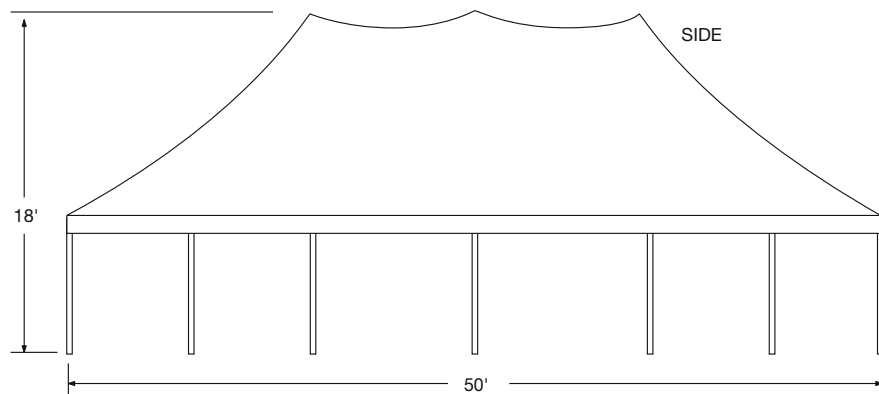
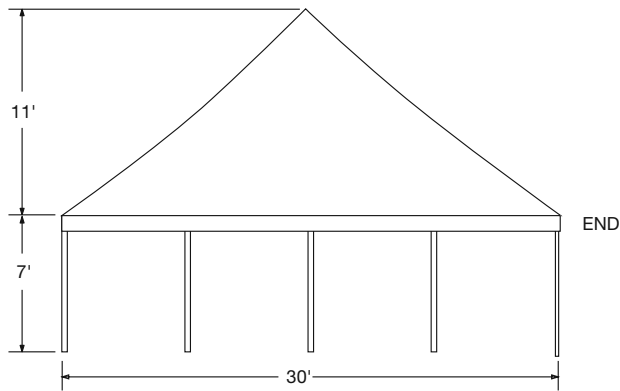

elite one piece canopy

30' X 60' WITH 7' SIDES

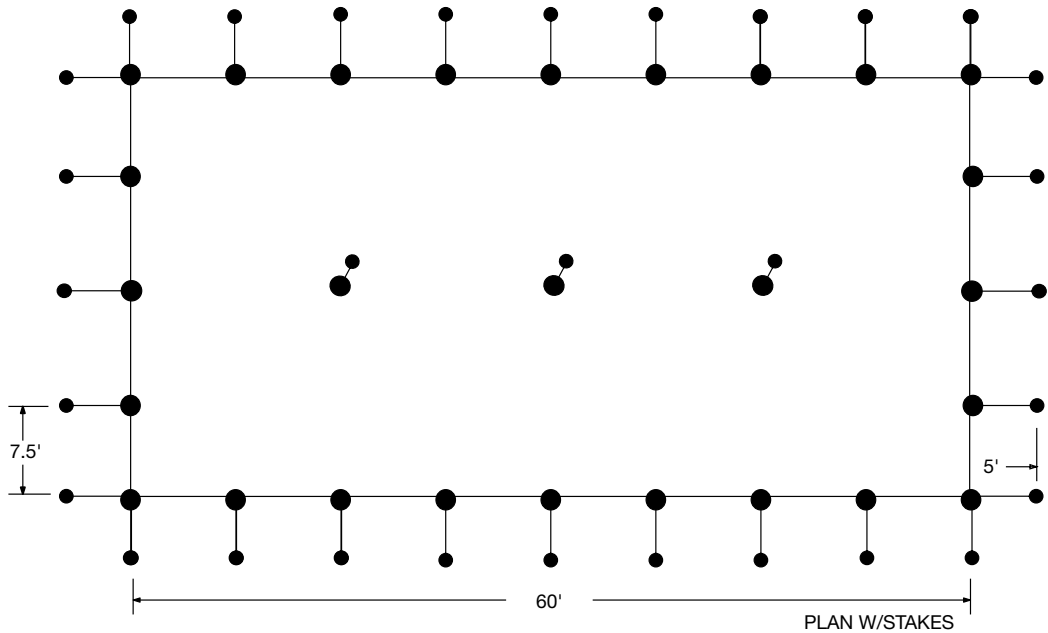

Note: Additional stakes will be necessary in soft soil conditions or whenever stakes pull up from the ground.

